

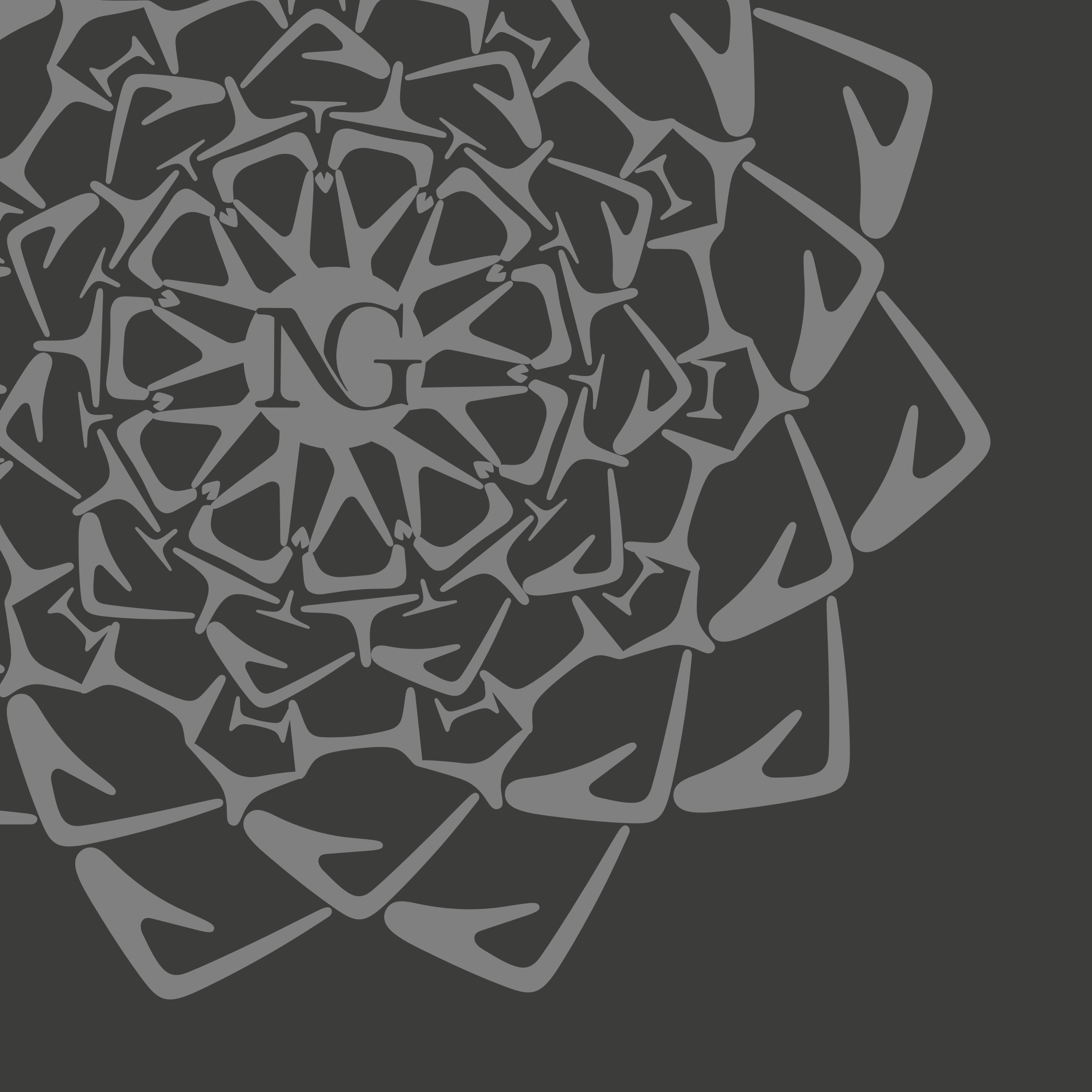

NG | STONE
PORCELAIN SLABS

PRODUCT CATALOGUE



NG | KUTAHYA
USA

NG | STONE
PORCELAIN SLABS



ngkutahyausa.com

Redefining the Limits of Ceramics with Innovation and Durability

NG Stone brings together durability, aesthetics, and cutting-edge innovation to elevate everyday living.

As a signature collection by NG Kütahya Seramik, NG Stone is crafted in Türkiye's largest indoor facility for granite-effect ceramic production.

Available in impressive 64×128 in cm (63×126 in) and 80×320 cm (31.5×126 in) dimensions with a thickness of 12 mm (0.47 in), NG Stone is the choice for those seeking a bold, elevated experience beyond conventional surfaces.

Ideal for countertops, sinks, kitchen cabinetry, TV wall panels, and more—this versatile porcelain slab collection unlocks endless creative possibilities across residential and commercial spaces.

Designed with hygiene, alternative surface textures, and broad application potential in mind, NG Stone also leads in sustainable manufacturing.

Its ultra-durable formula resists stains, chemicals, thermal shock, humidity, UV exposure, scratches, and abrasions—pushing the boundaries of what's possible in ceramic innovation.







Address: 7855 NW 41st, Doral, FL 33166 Suite #200

Email: sales@ngkutahyausa.com

Phone Number: (786) 953-6555

ngkutahyausa.com





The Bigger
The More Impressive.

NG | STONE
PORCELAIN SLABS



We remove the boundaries of your spaces.



**Hygiene, elegance
and durability
together**

As NG Kütahya Seramik, with our NG Stone brand, we take pride in being the first in the ceramic industry in Türkiye and one of only 11 companies worldwide to receive the NSF certification.



As the first ceramic company in Türkiye to receive NSF certification, we demonstrate our commitment to high quality and consumer health on surfaces that come into contact with food.



NG | **STONE**
PORCELAIN SLABS

For products certified by NSF, please visit NSF's official website at <https://info.nsf.org/Certified/Food/Listings.asp?Company=C0805209&Standard=051>. Only products bearing the NSF Mark are certified.

Your dream living spaces

in the

elegance

of porcelain
slabs



Easy to Clean



Suitable for Food Contact



Heat Resistant



Hygienic Surface



Stain Resistant



Scratch and Abrasion
Resistant



Chemical Resistant



Moisture Resistant



UV Resistant

INDEX

MARBLES		15				
APOLLO	16-17	ANTIQUE BEIGE BOOKMATCH	74-75	GRAINSTINE BROWN	132-133	
SWAN LIGHT GREY	18-19	CRYSTAL LUXOR	76-77	RAVEL BEIGE	134-135	
SWAN BONE	20-21	PIETRA GREY	78-79	TRAVERTINE IVORY	136-137	
SWAN GREY	22-23	RAPSODY GREY	80-81	TRAVERTEN RUBY	138-139	
SWAN LATTE	24-25	HONEY ONYX	82-83	CHESNUT	140-141	
DOLOMIT	26-27	PULPIS CHOCOLATE	84-85	CONCRETE		143
SAGA	28-29	GOLDEN NOIR	86-87	PORTLAND BEIGE	144-145	
STATUARIO FLASH	30-31	EGEAN BROWN	88-89	PORTLAND GREY	146-147	
STATUARIO FLASH BOOKMATCH	32-33	SIERRA MINK	90-91	PORTLAND LEAD GREY	148-149	
ARUNA GREY	34-35	ANATOLIAN BLACK	92-93	VISTA BONE	150-151	
WHITE FOREST	36-37	BAMBOO NOIR	94-95	VISTA GREY	152-153	
LINE WHITE	38-39	NERO MARQUINA	96-97	VISTA LEAD GREY	154-155	
INVISIBLE WHITE	40-41	PLACEBO	98-99	OXIDO BROWN	156-157	
INVISIBLE WHITE BOOKMATCH	42-43	VERDE PATRICIA	100-101	WOOD		159
VALERIA	44-45	DELMAR	102-103	CROSSWOOD OAK	160-161	
VALERIA BOOKMATCH	46-47	DELMAR BOOKMATCH	104-105	PALMWOOD NATURAL	162-163	
LOUIS	48-49	IRIS GREEN	106-107			
VICTORIA GOLD	50-51	ONICE RAINBOW	108-109			
ARABESCATO GILDA	52-53	ONICE RAINBOW BOOKMATCH	110-111			
ARABESCATO GILDA BOOKMATCH	54-55	OSSO	112-113			
CALACATTA GOLD	56-57	OSSO BOOKMATCH	114-115			
CALACATTA GOLD BOOKMATCH	58-59	STONE		117		
BRECCIA CAPRAIA	60-61	CALACATTA OREO	118-119			
BIANCO PAONAZZO	62-63	BIANCO ANTICO	120-121			
PANDA WHITE	64-65	NAPOLEON	122-123			
PANDA WHITE BOOKMATCH	66-67	SAHARA ROSE	124-125			
PANDA GREEN	68-69	LUTON BEIGE	126-127			
EMERALD GREEN	70-71	SAHARA GREY	128-129			
ANTIQUE BEIGE	72-73	COSMIC SILVER	130-131			

NG | STONE
PORCELAIN SLABS

Marble Textures

Apollo







64"x128"  **12MM**  **POLISHED**



Swan Light Grey

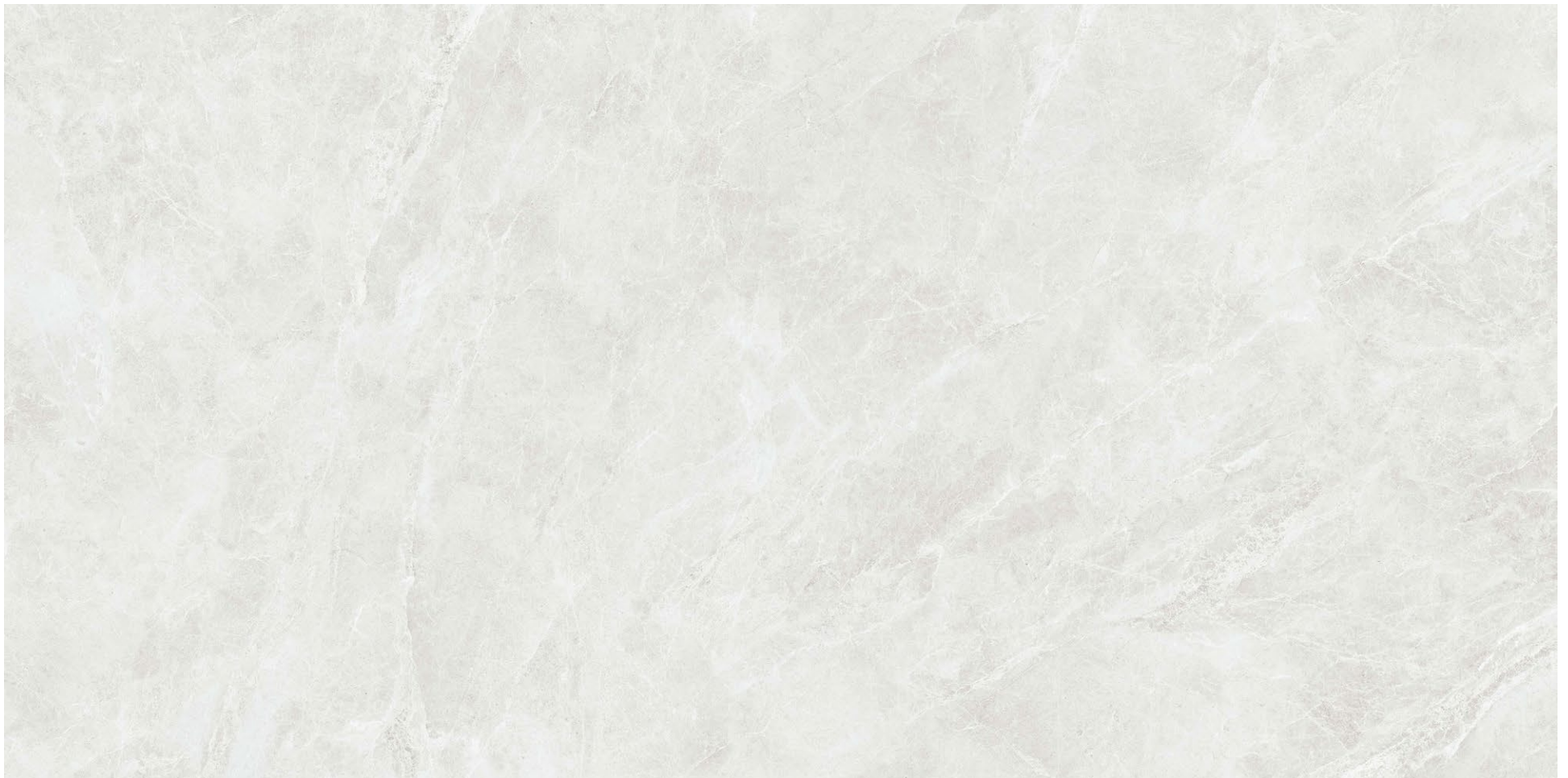



64"x128" 

12MM 

POLISHED

SOFT MATTE



Swan Bone





64"x128" 

12MM 

POLISHED

SOFT MATTE



Swan Grey





64"x128"  **12MM**  **POLISHED** **SOFT MATTE**



Swan Latte





64"x128" ✕ **12MM** ÷ **POLISHED** **SOFT MATTE**



Dolomit





64"x128"  **12MM**  **POLISHED** **SOFT MATTE**



Saga





64"x128"  **12MM**  **POLISHED** **SOFT MATTE**



Statuario Flash





64"x128" 

12MM 

POLISHED

SOFT MATTE



Statuario Flash Bookmatch





64"x128" 

12MM 

POLISHED

SOFT MATTE



Aruna Grey



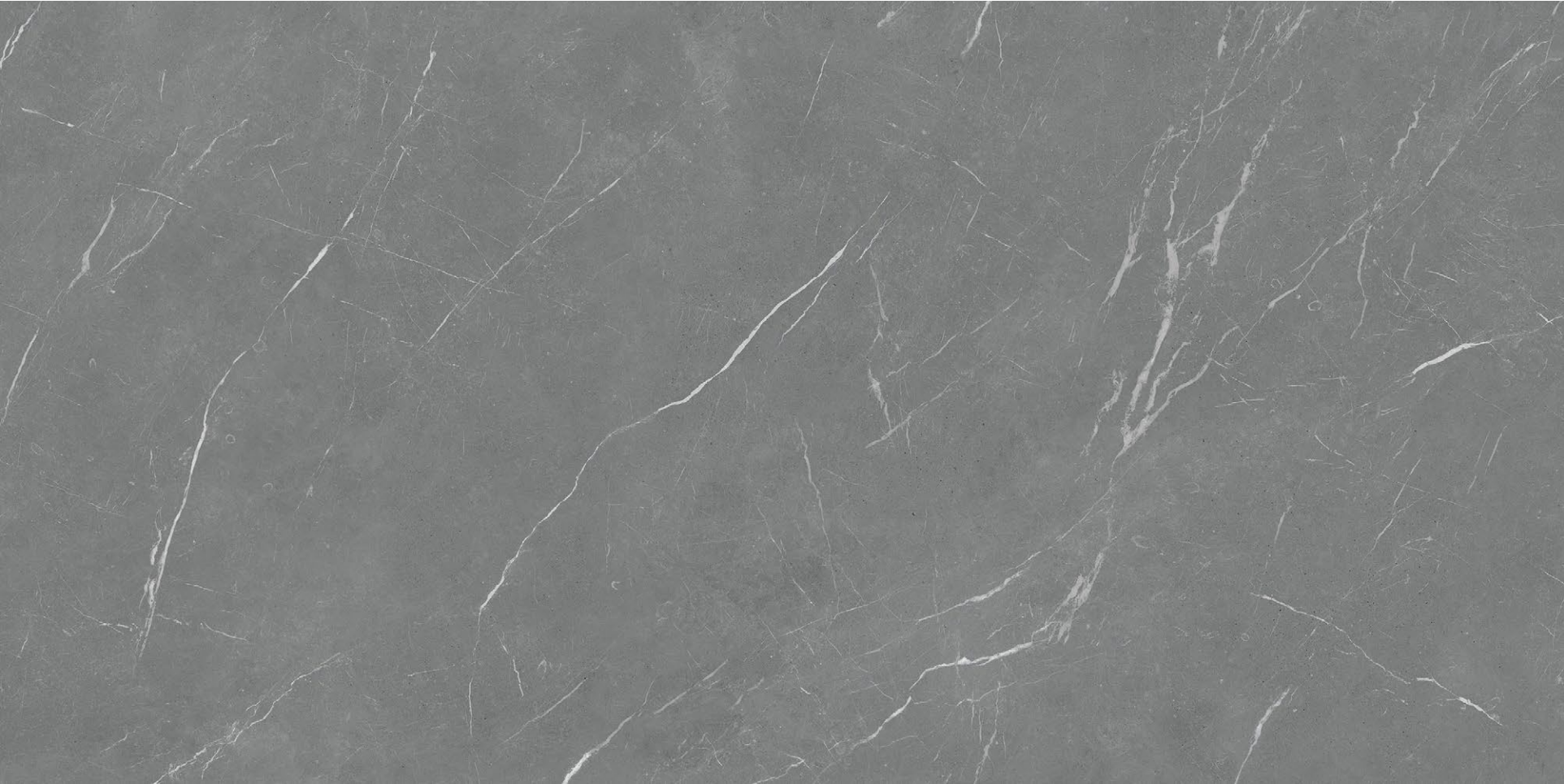



64"x128"  12MM  MATTE



White Forest





64"x128"  **12MM**  **POLISHED** **MATTE**



Line White





64"x128" 

12MM 

POLISHED

SOFT MATTE



Invisible White





64"x128"  12MM  POLISHED SOFT MATTE



Invisible White Bookmatch





64"x128"  **12MM**  **POLISHED** **SOFT MATTE**



Valeria





64"x128" 

12MM 

POLISHED

SOFT MATTE



**Valeria
Bookmatch**





64"x128"  **12MM**  **POLISHED** **SOFT MATTE**



Louis





64"x128"  **12MM**  **POLISHED** **SOFT MATTE**



Victoria Gold





64"x128" 

12MM 

POLISHED



Arabescato Gilda





64"x128" 

12MM 

POLISHED

SOFT MATTE



**Arabescato Gilda
Bookmatch**

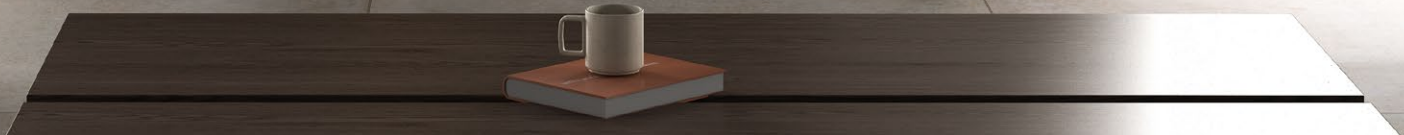
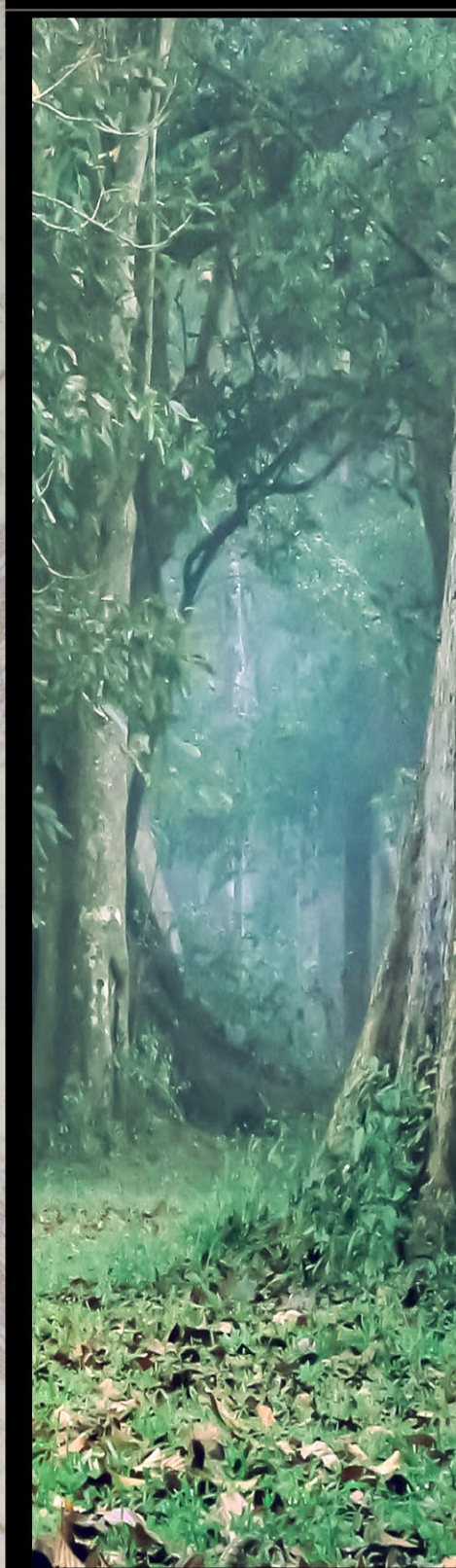



64"x128"  **12MM**  **POLISHED** **SOFT MATTE**



Calacatta Gold





64"x128" 

12MM 

POLISHED

SOFT MATTE



Calacatta Gold Bookmatch



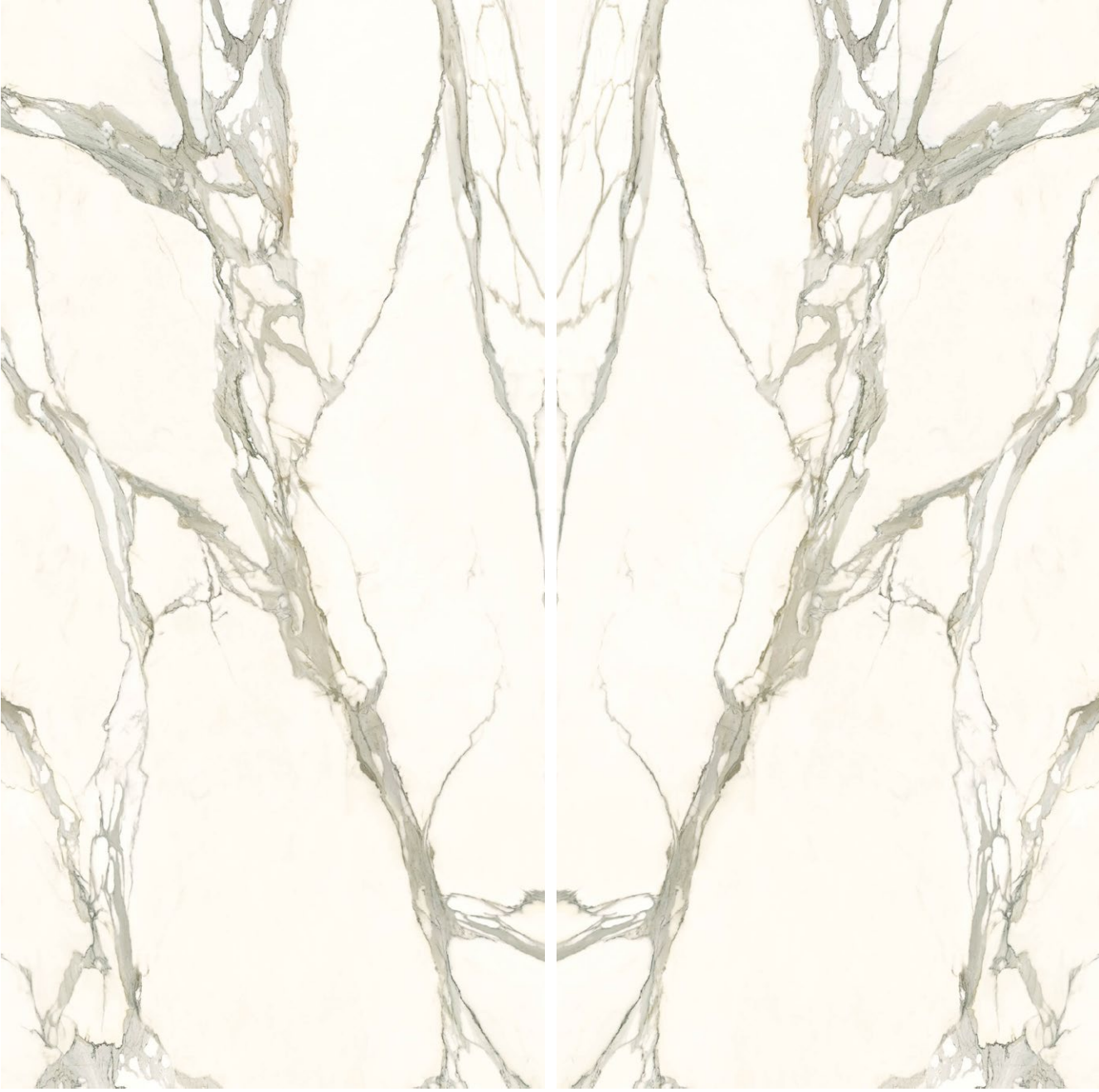

64"x128"  12MM  POLISHED SOFT MATTE



Breccia Capraia





64"x128"  12MM  POLISHED



Bianco Paonazzo





64"x128" 

12MM 

POLISHED

SOFT MATTE



Panda White





64"x128" 

12MM 

POLISHED



Panda White Bookmatch





64"x128" ✕ 12MM 1/8" POLISHED



Panda Green





64"x128" 

12MM 

POLISHED



Emerald Green





64"x128"  12MM  POLISHED



Antique Beige





64"x128" ✕ 12MM 1/8" POLISHED SOFT MATTE



**Antique Beige
Bookmatch**





64"x128"  12MM  POLISHED SOFT MATTE



Crystal Luxor

falmec





64"x128" 

12MM 

POLISHED



Pietra Grey





64"x128" ✕ **12MM** 1/8" **POLISHED** **MATTE**



Rapsody Grey





64"x128"  **12MM**  **POLISHED** **MATTE**



Honey Onyx





64"x128"  **12MM**  **POLISHED** **MATTE**



Pulpis Chocolate





64"x128"  12MM  MATTE



Golden Noir



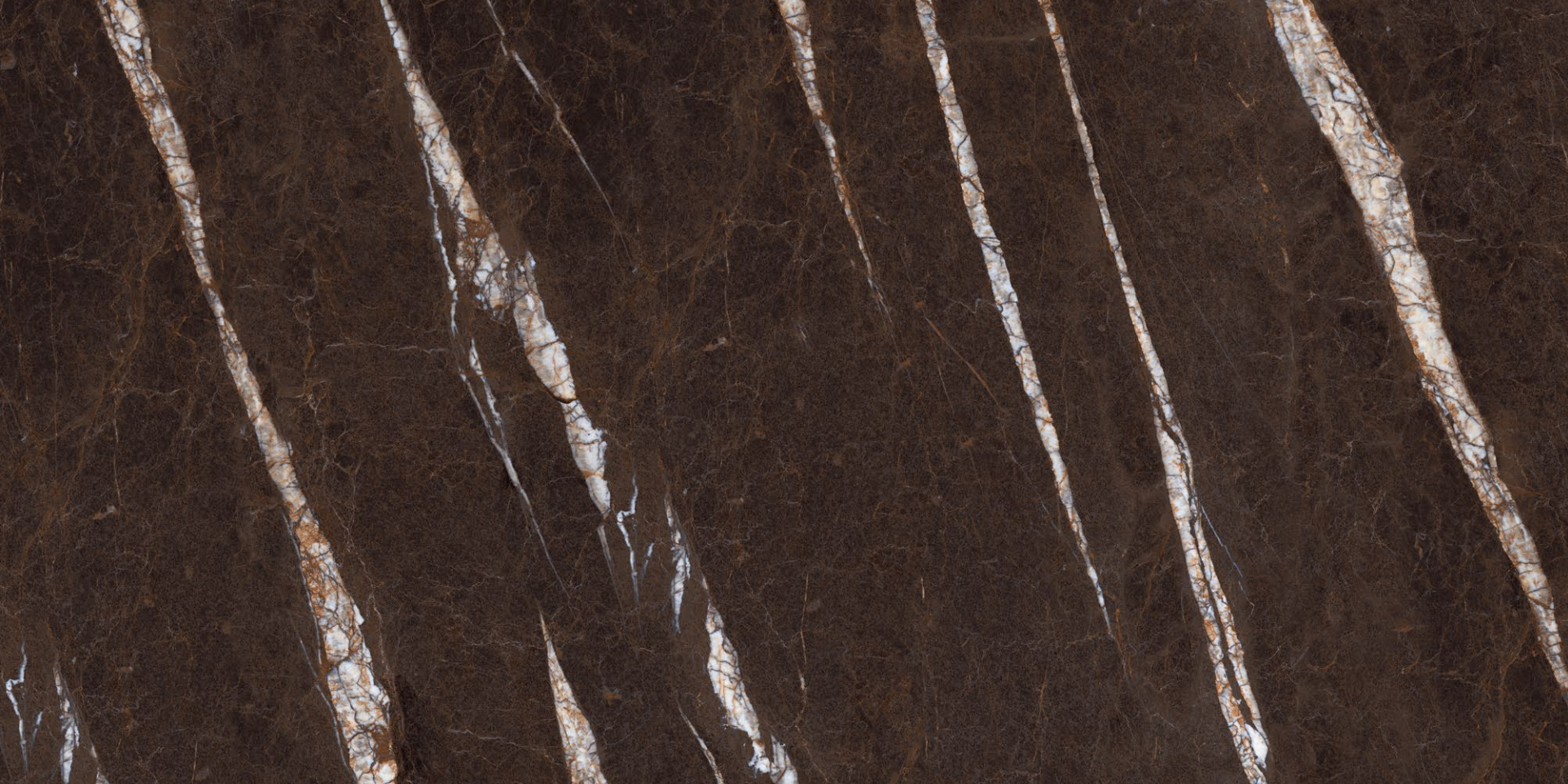

64"x128"  12MM  POLISHED



Egean Brown



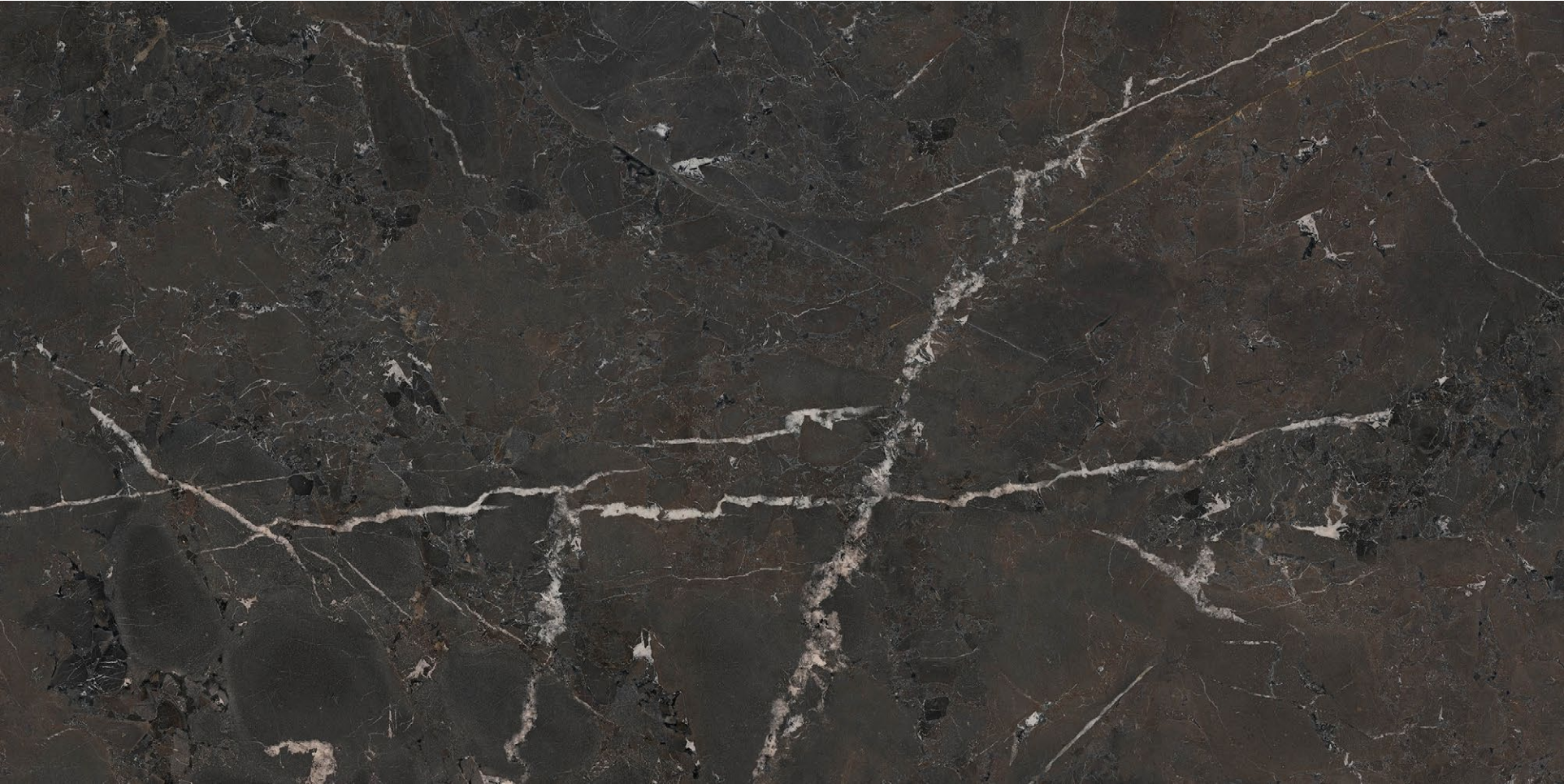



64"x128"  12MM  POLISHED MATTE



Sierra Mink

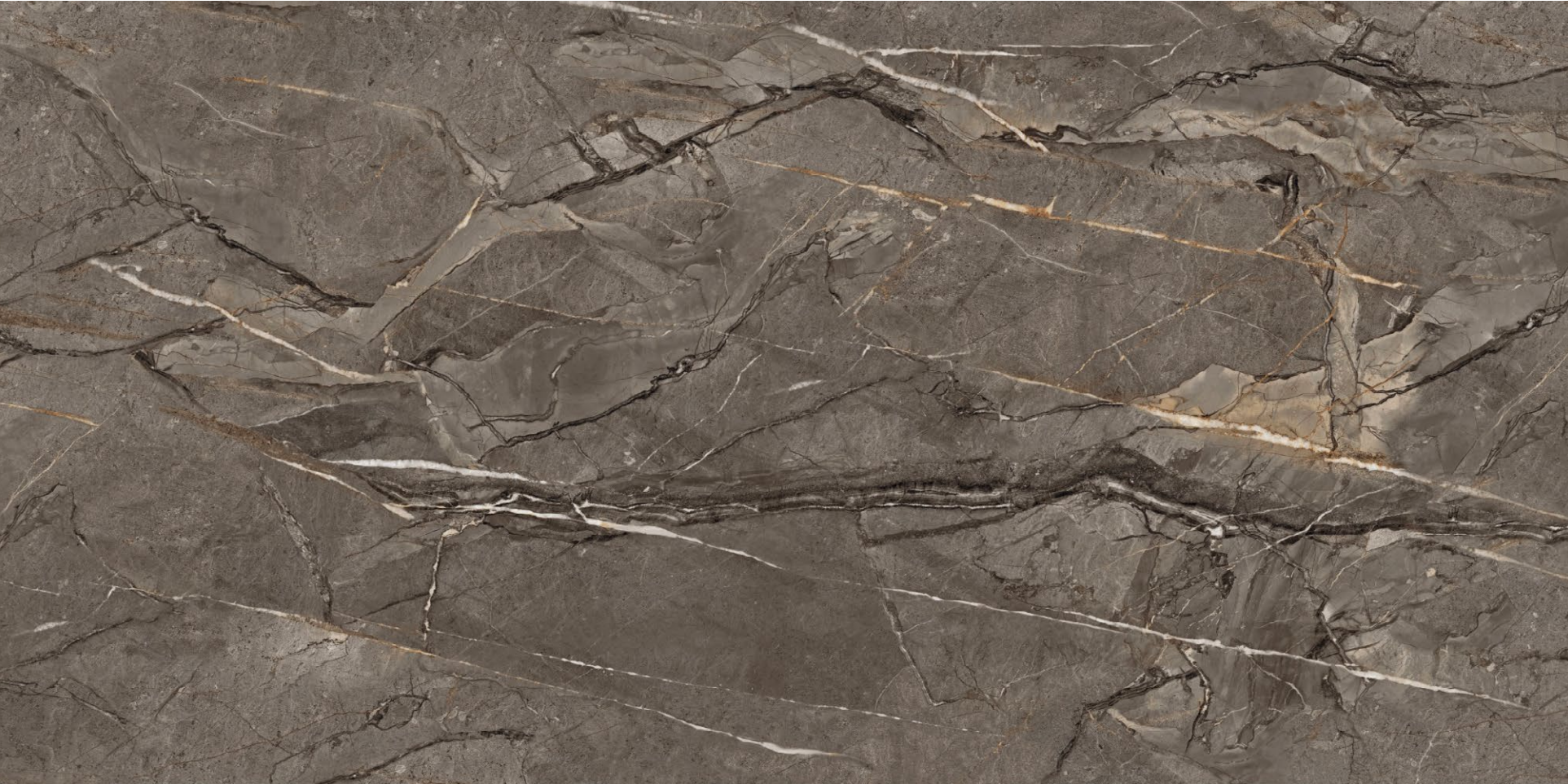





64"x128"  12MM  POLISHED MATTE



Anatolian Black





64"x128"  12MM  **POLISHED** **MATTE**



Bamboo Noir







64"x128"  12MM  POLISHED MATTE



Nero Marquina

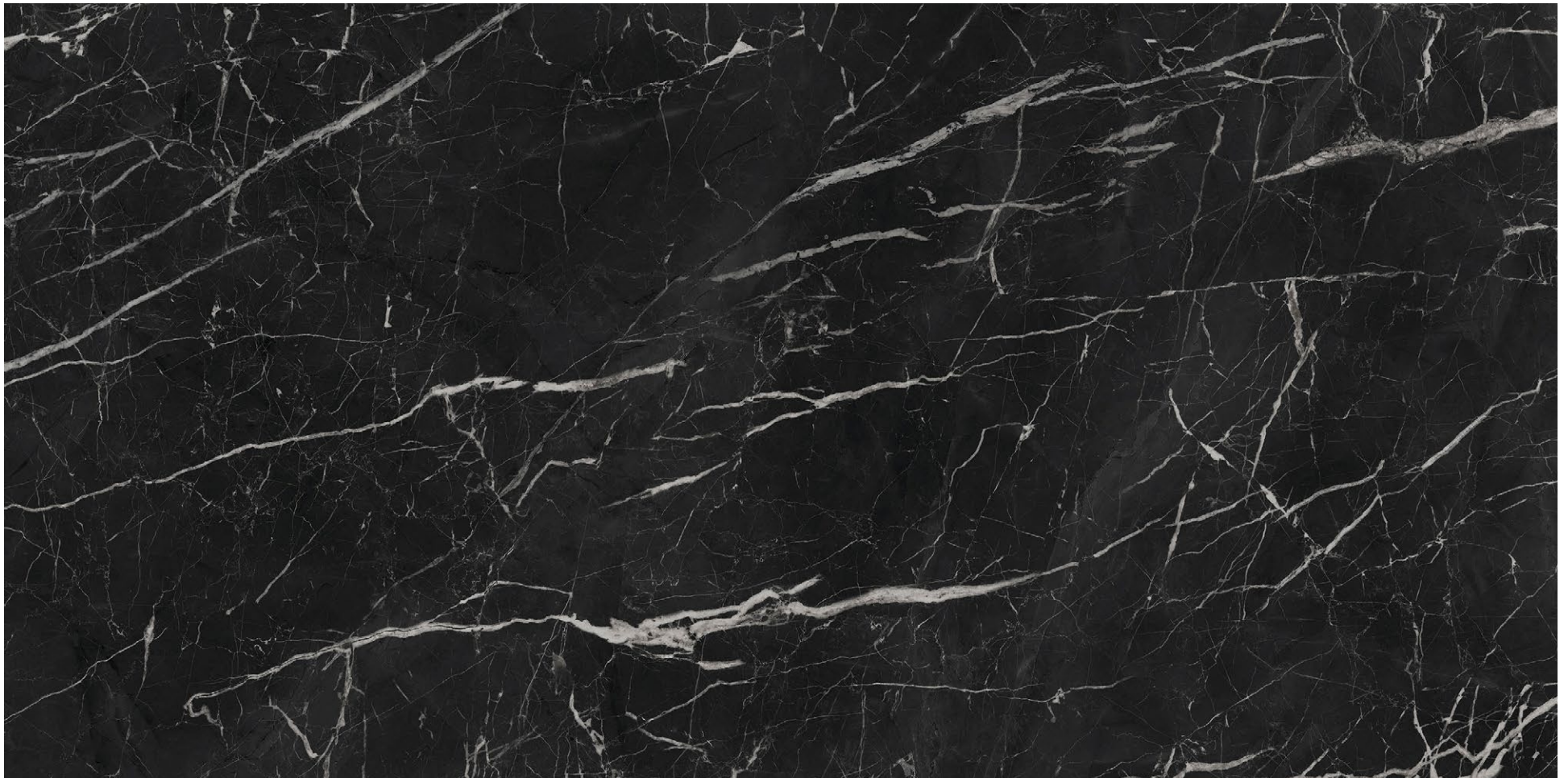



64"x128" 

12MM 

POLISHED



Placebo



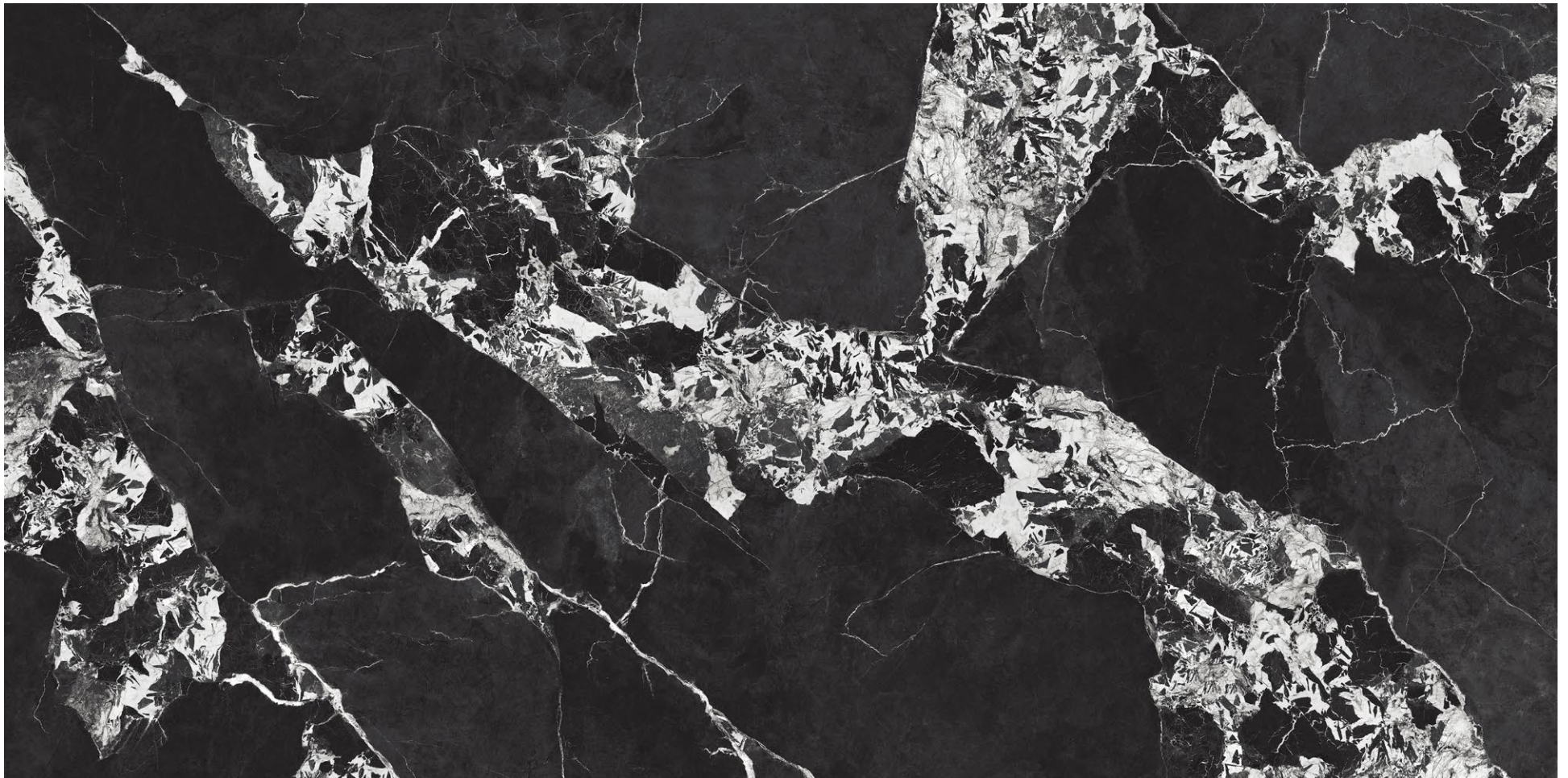

64"x128" 

12MM 

POLISHED



Verde Patricia







64"x128"  12MM  POLISHED



Delmar

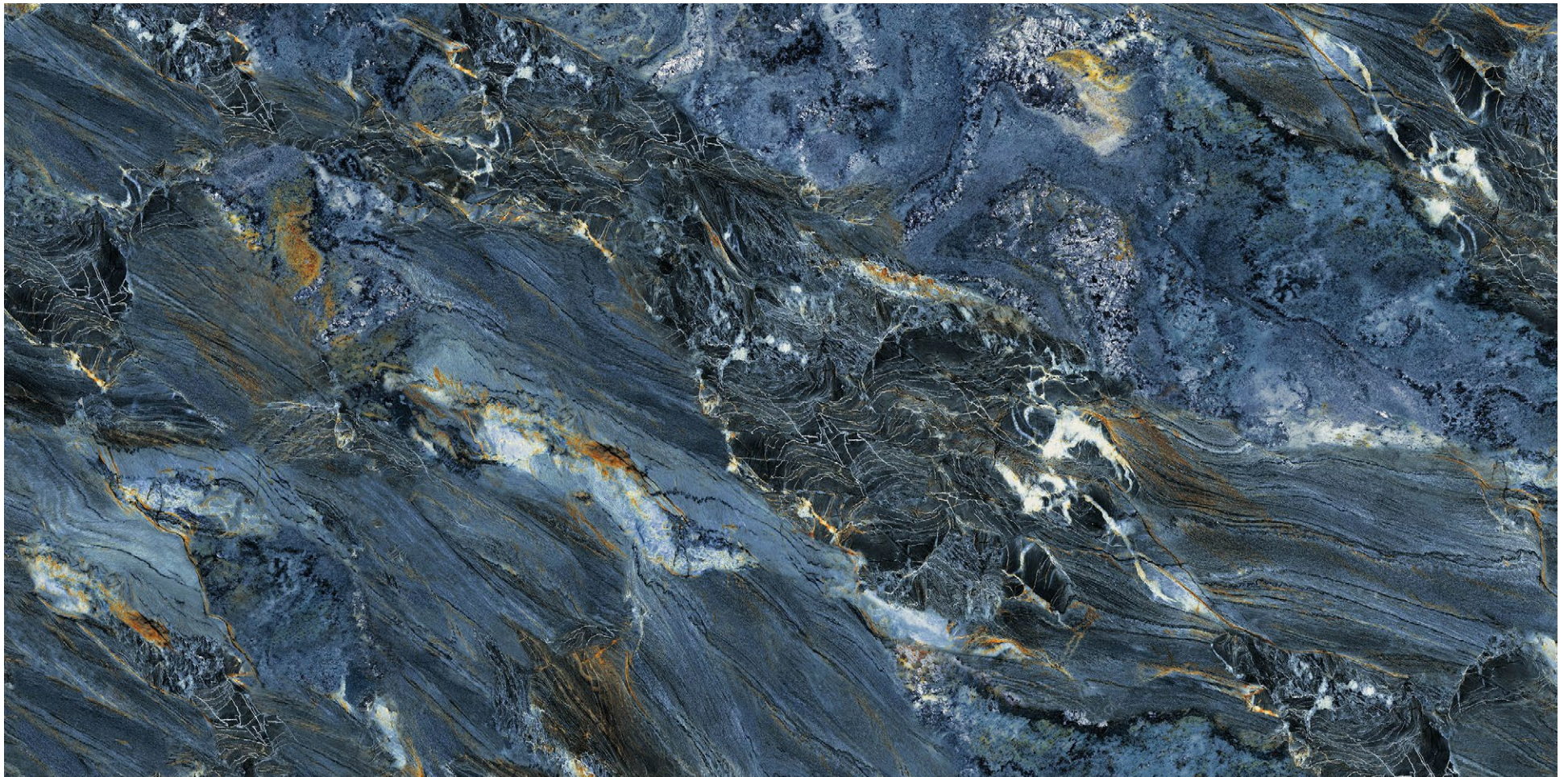



64"x128" 

12MM 

POLISHED



Delmar Bookmatch



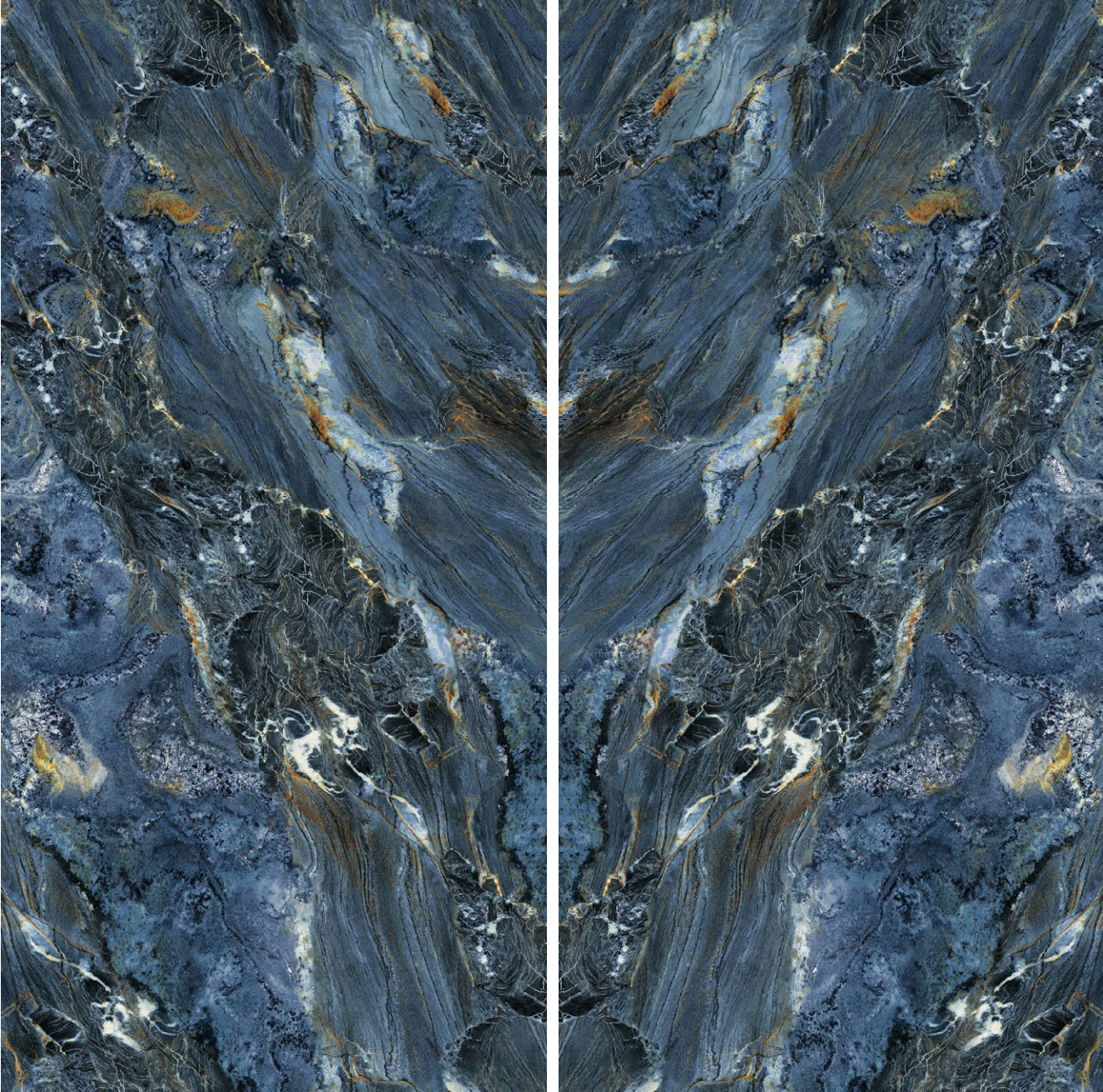

64"x128"  12MM  POLISHED



Iris Green







64"x128"  12MM  POLISHED



Onice Rainbow

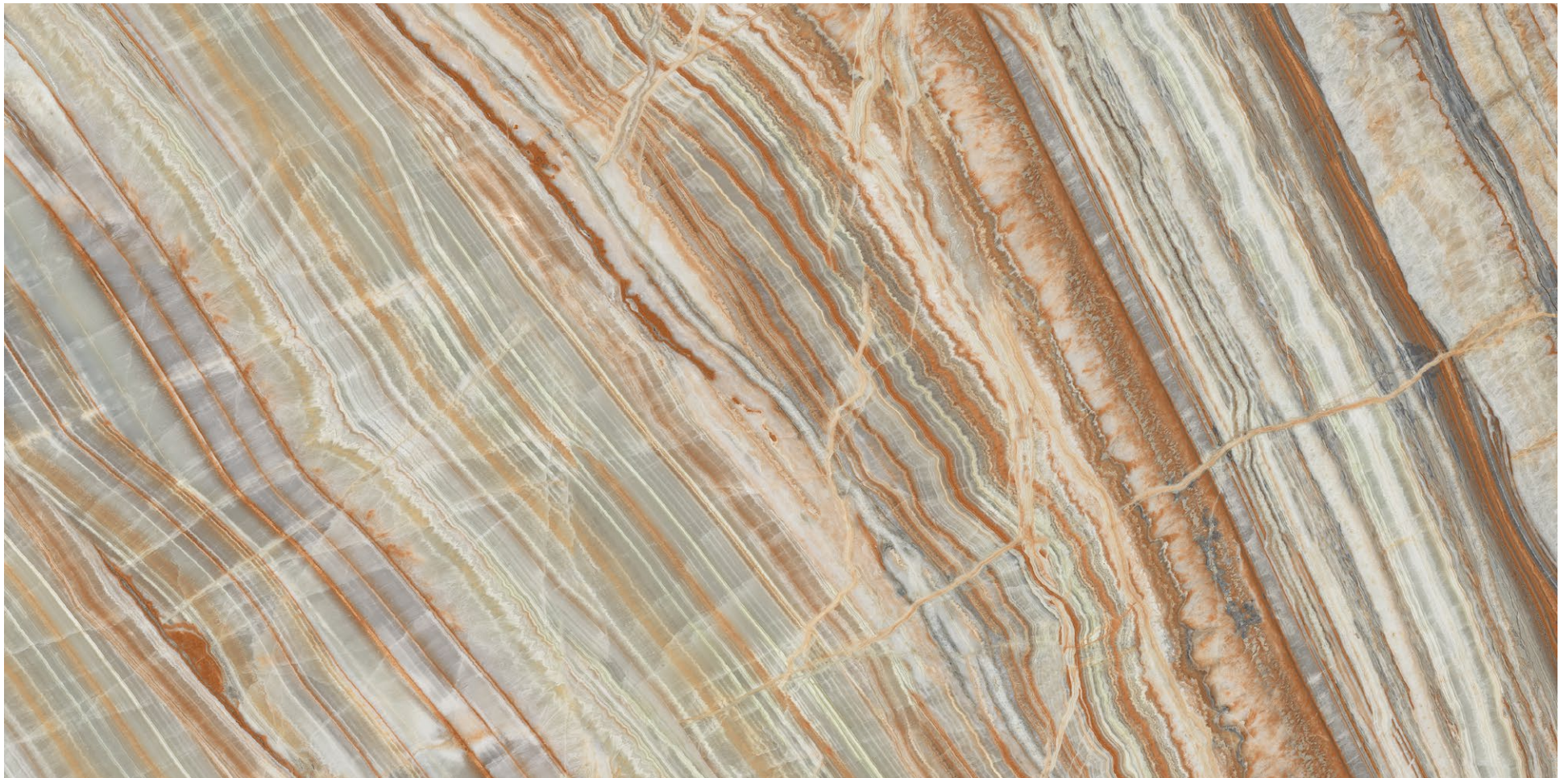



64"x128" 

12MM 

POLISHED



Onice Rainbow Bookmatch





64"x128"  12MM  POLISHED



Osso





64"x128"  12MM  MATTE



**Osso
Bookmatch**

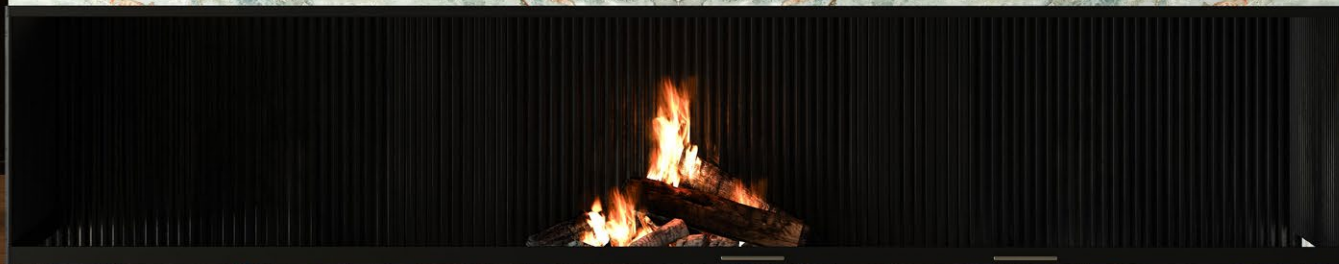

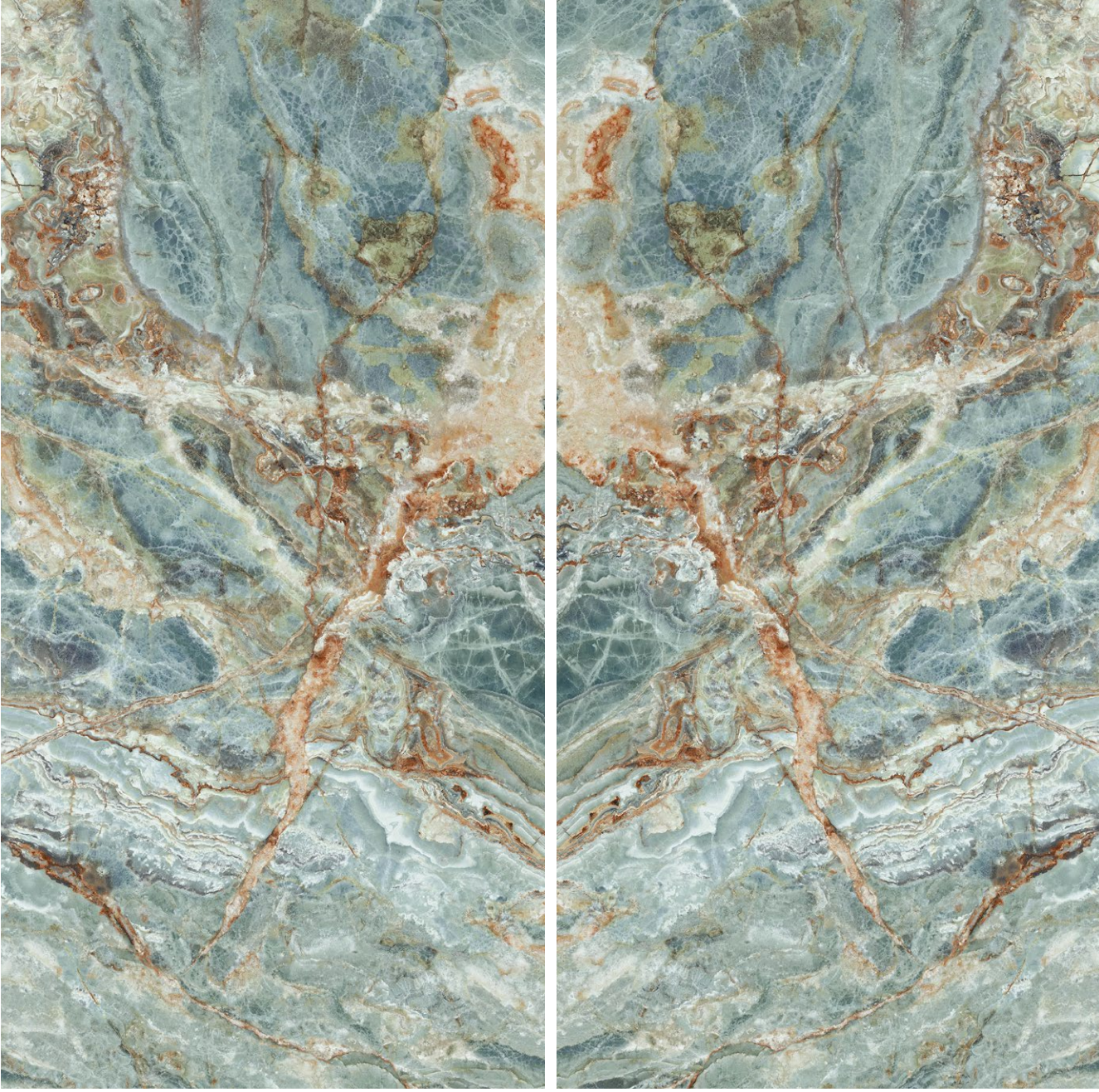

64"x128"  12MM  MATTE



NG | STONE
PORCELAIN SLABS

Stone Textures

Calacatta Oreo





64"x128"  **12MM**  **POLISHED** **MATTE**



Bianco Antico





64"x128" 

12MM 

POLISHED



Napoleon





64"x128"  12MM  POLISHED



Sahara Rose





64"x128" ✕ 12MM 1/4" POLISHED



Luton Beige





64"x128" 

12MM 

MATTE



Sahara Grey





64"x128"  12MM  MATTE



Cosmic Silver





64"x128" 

12MM 

POLISHED



Grainstone Brown



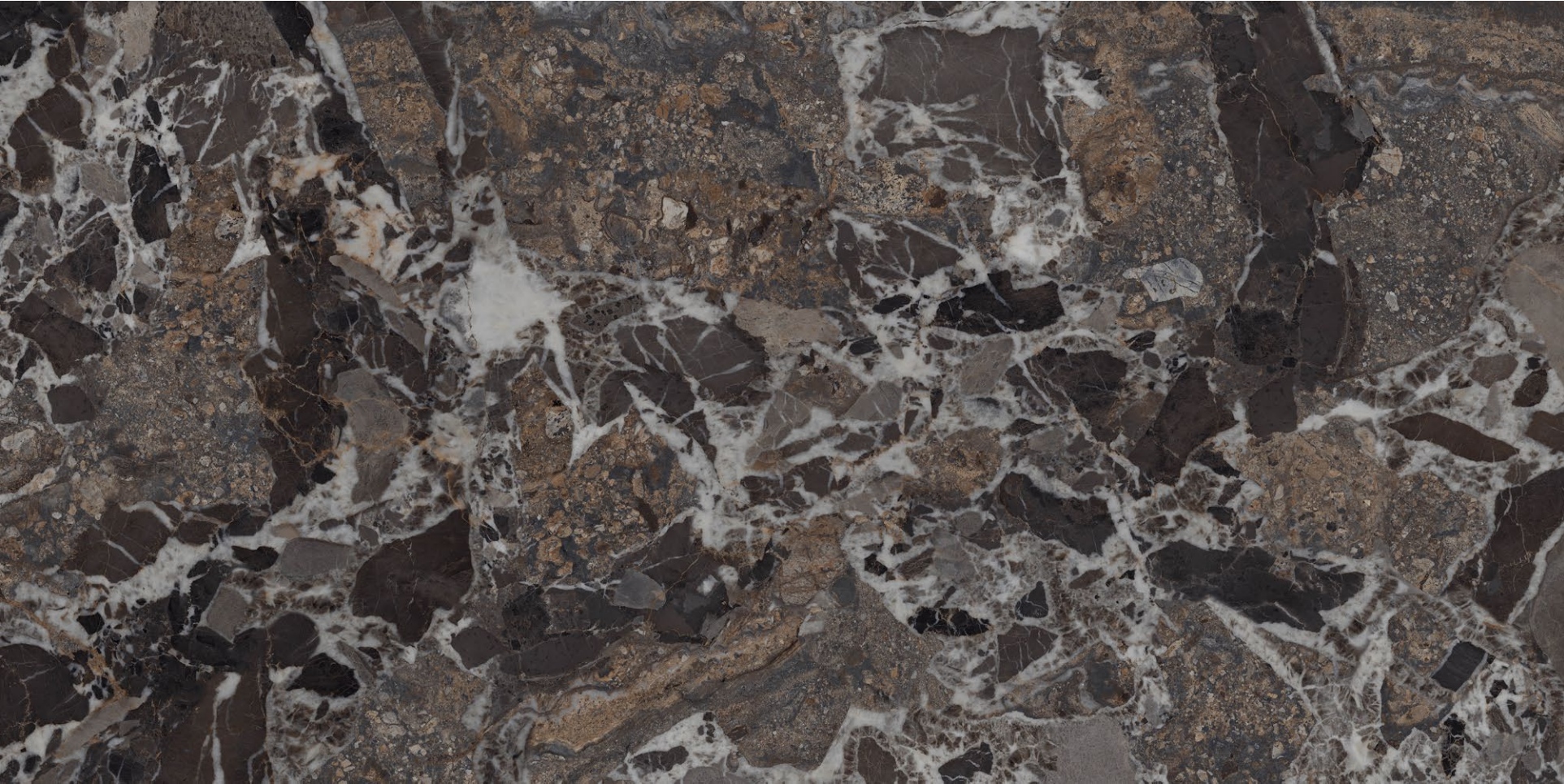

64"x128" ✕ 12MM 1/2" POLISHED



Ravel Beige





64"x128" 

12MM 

MATTE



Travertine Ivory





64"x128" 

12MM 

MATTE



Traverten Ruby



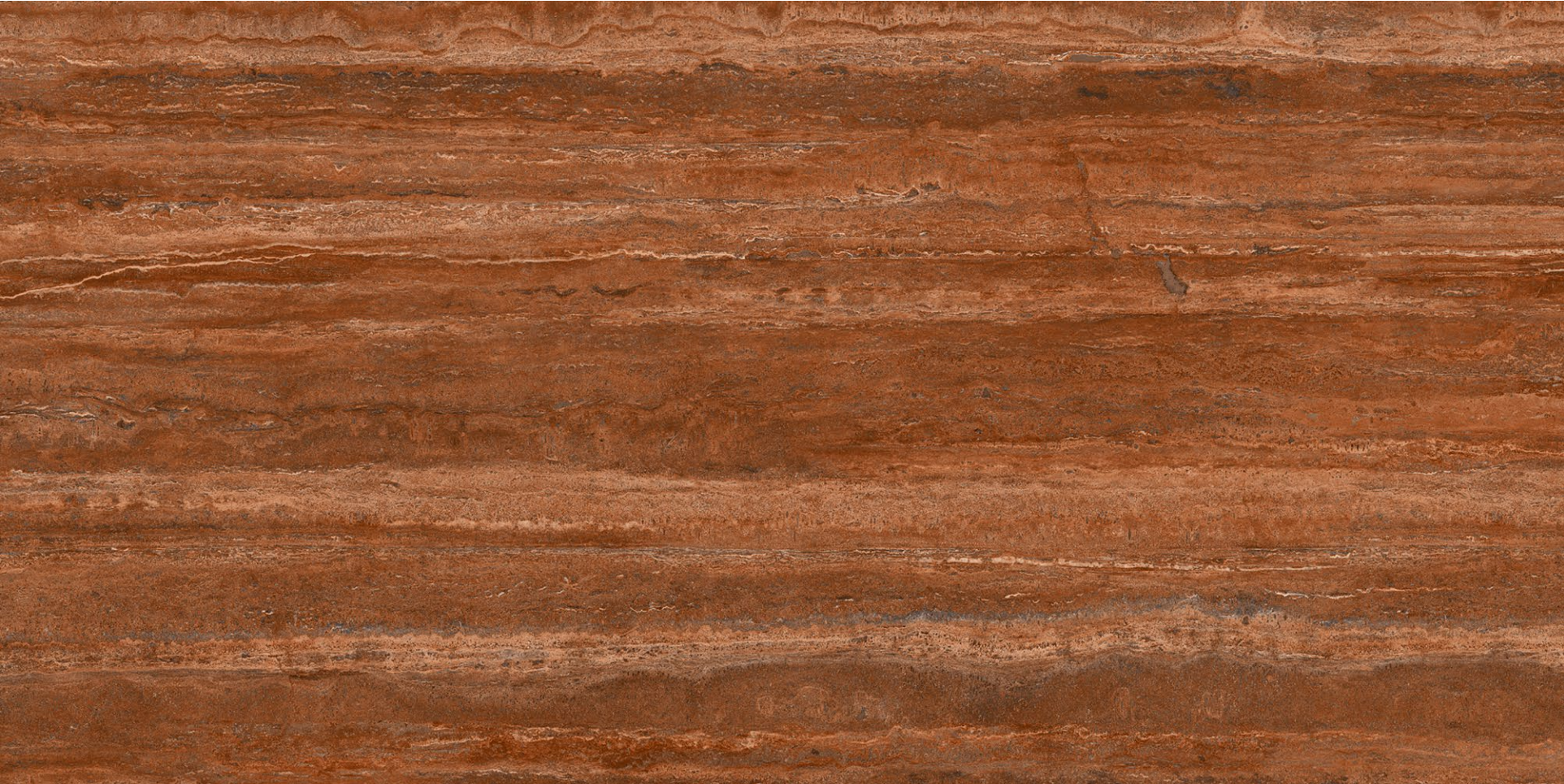

64"x128"  12MM  MATTE POLISHED



Chesnut



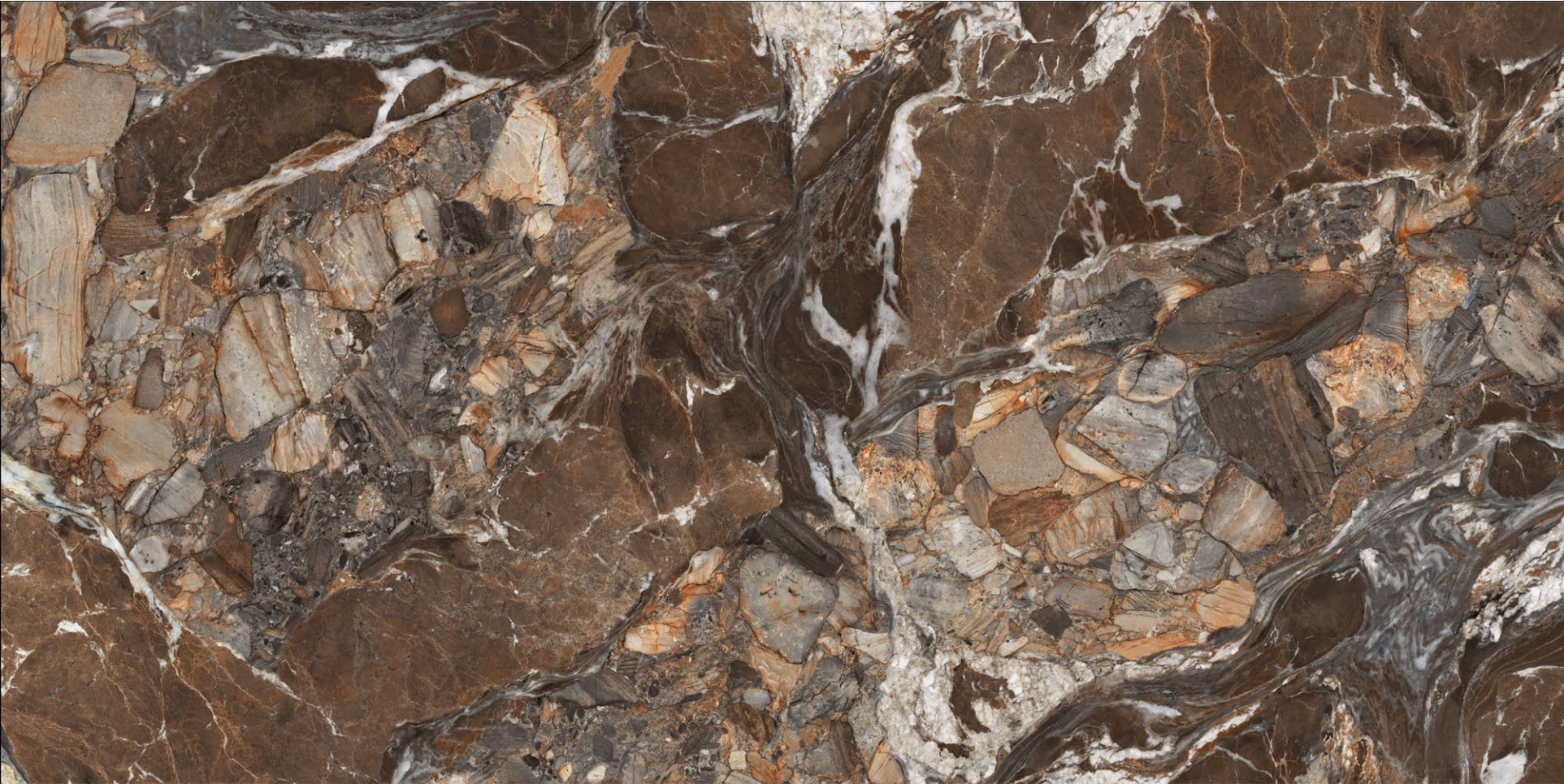

64"x128" ✕ 12MM ÷ POLISHED



NG | STONE
PORCELAIN SLABS

Concrete Textures

Portland Beige





64"x128" 

12MM 

MATTE



Portland Grey





64"x128" 

12MM 

MATTE



Portland Lead Grey





64"x128" 

12MM 

MATTE



Vista Bone





64"x128" 

12MM 

MATTE



Vista Grey





64"x128" 

12MM 

MATTE



Vista Lead Grey





64"x128"  12MM  MATTE



Oxido Brown





64"x128"  12MM  MATTE



NG | STONE
PORCELAIN SLABS

Wooden Textures

Crosswood Oak





64"x128" 

12MM 

MATTE



Palmwood Natural





64"x128"  12MM  MATTE





TECHNICAL DETAILS



NG STONE TRUCK LOADING INFORMATION



Metal A Frame 12 mm (64x128 inch)	Slab Thickness (mm)	Slab Surface	Total A Frame Piece	A Frame Slab Piece	Total Slab Piece	Total sqft	Lbs Slab	Lbs / A Frame (Including A Frame)	Track Loading Total Weight (Including A Frame)
	12	matt soft matt polished	8	20	160	8,815	330	6,889	55,115

Metal A Frame 12 mm (32x128 inch)	Slab Thickness (mm)	Slab Surface	Total A Frame Piece	A Frame Slab Piece	Total Slab Piece	Total sqft	Lbs Slab	Lbs / A Frame (Including A Frame)	Track Loading Total Weight (Including A Frame)
	12	matt soft matt polished	10	32	320	8,815	165	5,511	55,115

DURING THE UNLOADING OF THE A-FRAMES FROM THE VEHICLE, A FORKLIFT WITH A MINIMUM CAPACITY OF 11,023 LBS MUST BE USED. SPECIAL ATTENTION MUST BE PAID TO THIS REQUIREMENT.

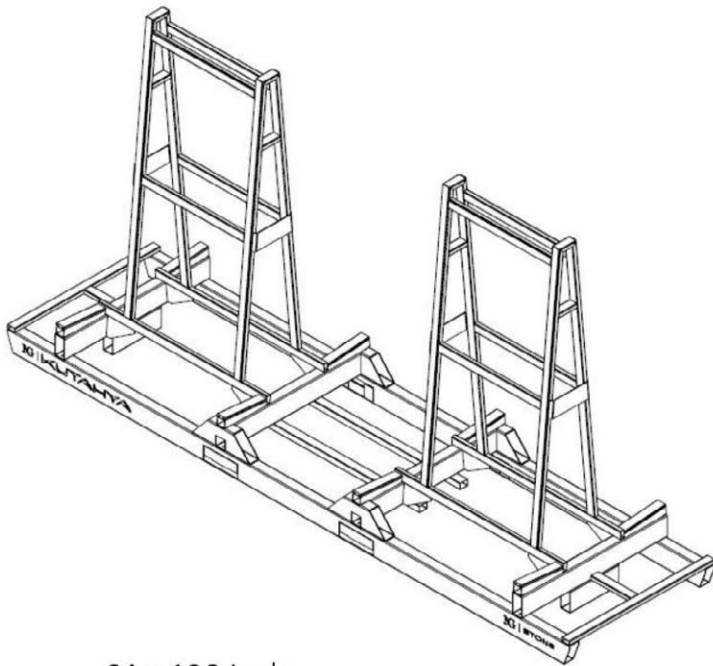

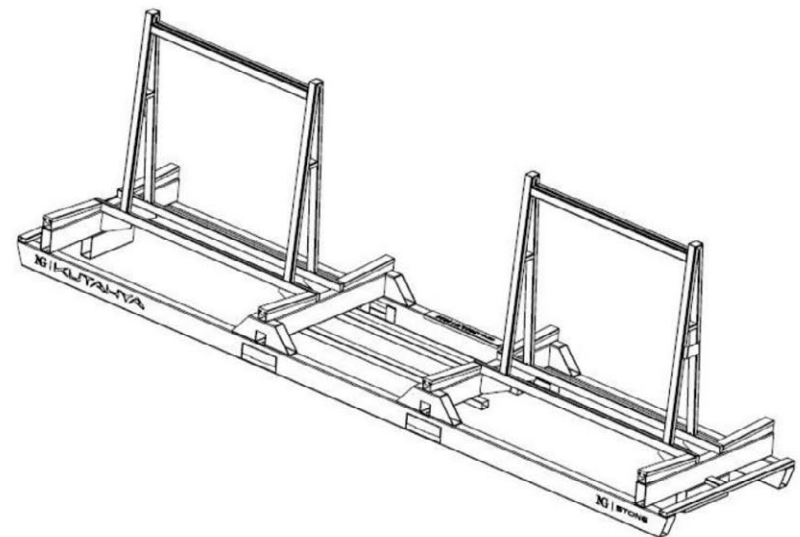

64 x 128 inch
A Frame Dimensions
132 x 30 x 78 (h) inch





32 x 128 inch
A Frame Dimensions
132 x 30 x 43 (h) inch

NG STONE PORCELAIN SLABS				GLAZED PORCELAIN TILES TECHNICAL CHARACTERISTICS (12 MM)	
Norms	Technical Characteristics		Required Values	NG STONE Glazed Product Declared Values *	
EN ISO 10545-2	Dimensions and surface quality	Length and width	± % 0,6 (± 2,0 mm)	-	
		Thickness	± % 5 (± 0,5 mm)	± % 5 (± 0,5 mm)	
		Straightness of sides	± % 0,5 (± 1,5 mm)	-	
		Rectangularity	± % 0,5 (± 2,0 mm)	-	
		Centre - edge curvature - warpage	± % 0,5 (± 2,0 mm)	+ % 0,2 / - % 0,1	
		Surface quality	% 95	% 95	
EN ISO 10545-3	Water absorption %		≤ % 0,5 (individual max. % 0,6)	≤ % 0,3	
EN ISO 10545-4	Breaking strength (N)	thickness ≥ 7,50mm	min. 1300 N	12 mm ≥ 3500 N 20 mm ≥ 10000 N	
		thickness < 7,50mm	min. 700 N	-	
	Modulus of rupture (N/mm ²)		min. 35 N/mm ²	12 mm ≥ 40 N/mm ² 20 mm ≥ 45 N/mm ²	
EN ISO 10545-5	Impact resistance as, coefficient of restitution (cor)		Declared value	Resistant	
EN ISO 10545-7	Abrasion resistance		Abrasion class and cycles passed	Class 2 - 3 - 4	
EN ISO 10545-8	Linear thermal expansion		Declared value	5,70 x10 ⁻⁶ - 7,50 x10 ⁻⁶	
EN ISO 10545-9	Thermal shock resistance		Required	Resistant	
EN ISO 10545-10	Moisture expansion		Declared value	0,01%	
EN ISO 10545-11	Crazing resistance		Required	Resistant	
EN ISO 10545-12	Frost resistance		Required	Resistant	
EN ISO 10545-13	Resistance to low concentrations of acids and alkalis		Declared value	LA/LB	
	Resistance to high concentrations of acids and alkalis		Declared value	HA/HB	
	Resistance to household chemicals and swimming pool salts		min. B	A A	
EN ISO 10545-14	Resistance to staining		min. 3.class	min. 3.class	
EN ISO 10545-15	Release of dangerous substance Lead - Cadmium		Declared value	Pb < 0,1 Cd < 0,01	
DIN 51130-51097 CEN/TS 16165	Slipperiness		Declared value	Class R9 - R10 - R11 - R12	
EN 12004:2007+A1:2012,4,1	Bond strength adhesion	Cementitious adhesives	Declared value	≥ 1,0 Tip C2	
EN 12004:2007+A1:2012,4,2		Dispersion adhesives	Declared value		
EN 12004:2007+A1:2012,4,3		Reaction resin adhesives	Declared value		
		Mortar	Declared value		
	Reaction to fire		A1 or A1 _{FL}	A1 or A1 _{FL}	
CEN/TS15209	Tactility		Declare surface description	Declare surface description	
<p>Notes</p> <p>* EN 14411 Dry pressed ceramic tiles with low water absorption Ek G (Grup Bla) E < %0,5 glazed (GL)</p> <p>* The test results refer only to first choice items and they do not regard the trimtiles. The values are based on average production values.</p> <p>* NG Kütahya Seramik reserve the right to modify technical and formal details included in this catalog.</p>					

NG STONE PORCELAIN SLABS				GLAZED PORCELAIN TILES TECHNICAL CHARACTERISTICS (RECTIFIED 12 MM)	
Norms	Technical Characteristics		Required Values	NG STONE Glazed Product Declared Values *	
EN ISO 10545-2	Dimensions and surface quality	Length and width	± % 0,6 (± 2,0 mm)	± % 0,3	
		Thickness	± % 5 (± 0,5 mm)	± % 5 (± 0,5 mm)	
		Straightness of sides	± % 0,5 (± 1,5 mm)	± % 0,3	
		Rectangularity	± % 0,5 (± 2,0 mm)	± % 0,3	
		Centre - edge curvature - warpage	± % 0,5 (± 2,0 mm)	+ % 0,2 / - % 0,1	
		Surface quality	% 95	% 95	
EN ISO 10545-3	Water absorption %		≤ % 0,5 (individual max. % 0,6)	≤ % 0,3	
EN ISO 10545-4	Breaking strength (N)	thickness ≥ 7,50mm	min. 1300 N	12 mm ≥ 3500 N 20 mm ≥ 10000 N	
		thickness < 7,50mm	min. 700 N	-	
	Modulus of rupture (N/mm ²)		min. 35 N/mm ²	12 mm ≥ 40 N/mm ² 20 mm ≥ 45 N/mm ²	
EN ISO 10545-5	Impact resistance as, coefficient of restitution (cor)		Declared value	Resistant	
EN ISO 10545-7	Abrasion resistance		Abrasion class and cycles passed	Class 2 - 3 - 4	
EN ISO 10545-8	Linear thermal expansion		Declared value	5,70 x10 ⁻⁶ - 7,50 x10 ⁻⁶	
EN ISO 10545-9	Thermal shock resistance		Required	Resistant	
EN ISO 10545-10	Moisture expansion		Declared value	0,01%	
EN ISO 10545-11	Crazing resistance		Required	Resistant	
EN ISO 10545-12	Frost resistance		Required	Resistant	
EN ISO 10545-13	Resistance to low concentrations of acids and alkalis		Declared value	LA/LB	
	Resistance to high concentrations of acids and alkalis		Declared value	HA/HB	
	Resistance to household chemicals and swimming pool salts		min. B	A	
EN ISO 10545-14	Resistance to staining		min. 3.class	min. 3.class	
EN ISO 10545-15	Release of dangerous substance Lead - Cadmium		Declared value	Pb < 0,1 Cd < 0,01	
DIN 51130-51097 CEN/TS 16165	Slipperiness		Declared value	Class R9 - R10 - R11 - R12	
EN 12004:2007+A1:2012,4,1	Bond strength adhesion	Cementitious adhesives	Declared value	≥ 1,0 Tip C2	
EN 12004:2007+A1:2012,4,2		Dispersion adhesives	Declared value		
EN 12004:2007+A1:2012,4,3		Reaction resin adhesives	Declared value		
		Mortar	Declared value		
	Reaction to fire		A1 or A1 _{FL}	A1 or A1 _{FL}	
CEN/TS15209	Tactility		Declare surface description	Declare surface description	
<p>Notes</p> <p>* EN 14411 Dry pressed ceramic tiles with low water absorption Ek G (Grup Bla) E < %0,5 glazed (GL)</p> <p>* The test results refer only to first choice items and they do not regard the trimtiles. The values are based on average production values.</p> <p>* NG Kütahya Seramik reserve the right to modify technical and formal details included in this catalog.</p>					

				GLAZED PORCELAIN TILES TECHNICAL CHARACTERISTICS (MATT - SOFT MATT 6 MM)	
Norms	Technical Characteristics		Required Values	NG Stone Glazed Product Declared Values *	
EN ISO 10545-2	Dimensions and surface quality	Length and width	± % 0,6 (± 2,0 mm)	-	
		Thickness	± % 5 (± 0,5 mm)	± % 5	
		Straightness of sides	± % 0,5 (± 1,5 mm)	-	
		Rectangularity	± % 0,5 (± 2,0 mm)	-	
		Surface Flatness	± % 0,5 (± 2,0 mm)	-	
		Surface quality	% 95	% 95	
EN ISO 10545-3	Water absorption %		≤ % 0,5 (individual max. % 0,6)	≤ % 0,3	
EN ISO 10545-4	Breaking strength (N)	thickness ≥ 7,50mm	min. 1300 N	-	
		thickness < 7,50mm	min. 700 N	min. 850 N	
	Modulus of rupture (N/mm ²)		min. 35 N/mm ²	≥ 45 N/mm ²	
EN ISO 10545-5	Impact resistance as, coefficient of restitution (cor)		Declared value	Resistant	
EN ISO 10545-7	Abrasion resistance		Abrasion class and cycles passed	Class 2 - 3 - 4	
EN ISO 10545-8	Linear thermal expansion		Declared value	5,70 x10 ⁻⁴ - 7,50 x10 ⁻⁴	
EN ISO 10545-9	Thermal shock resistance		Required	Resistant	
EN ISO 10545-10	Moisture expansion		Declared value	0,01%	
EN ISO 10545-11	Crazing resistance		Required	Resistant	
EN ISO 10545-12	Frost resistance		Required	Resistant	
EN ISO 10545-13	Resistance to low concentrations of acids and alkalis		Declared value	LA	
	Resistance to high concentrations of acids and alkalis		Declared value	HA	
	Resistance to household chemicals and swimming pool salts		min. B	A	
EN ISO 10545-14	Resistance to staining		min. 3.class	min. 3.class	
EN ISO 10545-15	Release of dangerous substance Lead - Cadmium		Declared value	Pb < 0,1 Cd < 0,01	
EN 12004:2007+A1:2012,4,1	Bond strength adhesion	Cementitious adhesives	Declared value	≥ 1,0 Tip C2	
	Reaction to fire		A1 or A1 _{FL}	A1 or A1 _{FL}	
CEN/TS15209	Tactility		Declare surface description	Declare surface description	
<p>Notes</p> <p>* EN 14411 Dry pressed ceramic tiles with low water absorption Ek G (Grup Bla) E < %0,5 glazed (GL)</p> <p>* The test results refer only to first choice items and they do not regard the trimtiles. The values are based on average production values.</p> <p>* NG Kütahya Seramik reserve the right to modify technical and formal details included in this catalog.</p>					

				GLAZED PORCELAIN TILES TECHNICAL CHARACTERISTICS (MATT - SOFT MATT RECTIFIED 6 MM)	
Norms	Technical Characteristics		Required Values	NG Stone Glazed Product Declared Values *	
EN ISO 10545-2	Dimensions and surface quality	Length and width	± % 0,6 (± 2,0 mm)	± % 0,3	
		Thickness	± % 5 (± 0,5 mm)	± % 5	
		Straightness of sides	± % 0,5 (± 1,5 mm)	± % 0,3	
		Rectangularity	± % 0,5 (± 2,0 mm)	± % 0,3	
		Surface Flatness	± % 0,5 (± 2,0 mm)	± % 0,3	
		Surface quality	% 95	% 95	
EN ISO 10545-3	Water absorption %		≤ % 0,5 (individual max. % 0,6)	≤ % 0,3	
EN ISO 10545-4	Breaking strength (N)	thickness ≥ 7,50mm	min. 1300 N	-	
		thickness < 7,50mm	min. 700 N	min. 850 N	
	Modulus of rupture (N/mm ²)		min. 35 N/mm ²	≥ 45 N/mm ²	
EN ISO 10545-5	Impact resistance as, coefficient of restitution (cor)		Declared value	Resistant	
EN ISO 10545-7	Abrasion resistance		Abrasion class and cycles passed	Class 2 - 3 - 4	
EN ISO 10545-8	Linear thermal expansion		Declared value	5,70 x10 ⁻⁴ - 7,50 x10 ⁻⁴	
EN ISO 10545-9	Thermal shock resistance		Required	Resistant	
EN ISO 10545-10	Moisture expansion		Declared value	0,01%	
EN ISO 10545-11	Crazing resistance		Required	Resistant	
EN ISO 10545-12	Frost resistance		Required	Resistant	
EN ISO 10545-13	Resistance to low concentrations of acids and alkalis		Declared value	LA	
	Resistance to high concentrations of acids and alkalis		Declared value	HA	
	Resistance to household chemicals and swimming pool salts		min. B	A	
EN ISO 10545-14	Resistance to staining		min. 3.class	min. 3.class	
EN ISO 10545-15	Release of dangerous substance Lead - Cadmium		Declared value	Pb < 0,1 Cd < 0,01	
EN 12004:2007+A1:2012,4,1	Bond strength adhesion	Cementitious adhesives	Declared value	≥ 1,0 Tip C2	
	Reaction to fire		A1 or A1 _{FL}	A1 or A1 _{FL}	
CEN/TS15209	Tactility		Declare surface description	Declare surface description	
<p>Notes</p> <p>* EN 14411 Dry pressed ceramic tiles with low water absorption Ek G (Grup Bla) E < %0,5 glazed (GL)</p> <p>* The test results refer only to first choice items and they do not regard the trimtiles. The values are based on average production values.</p> <p>* NG Kütahya Seramik reserve the right to modify technical and formal details included in this catalog.</p>					

Quality Certificates



Please visit our website to review our product compliance certificates and other relevant certifications.



ngkutahyusa.com

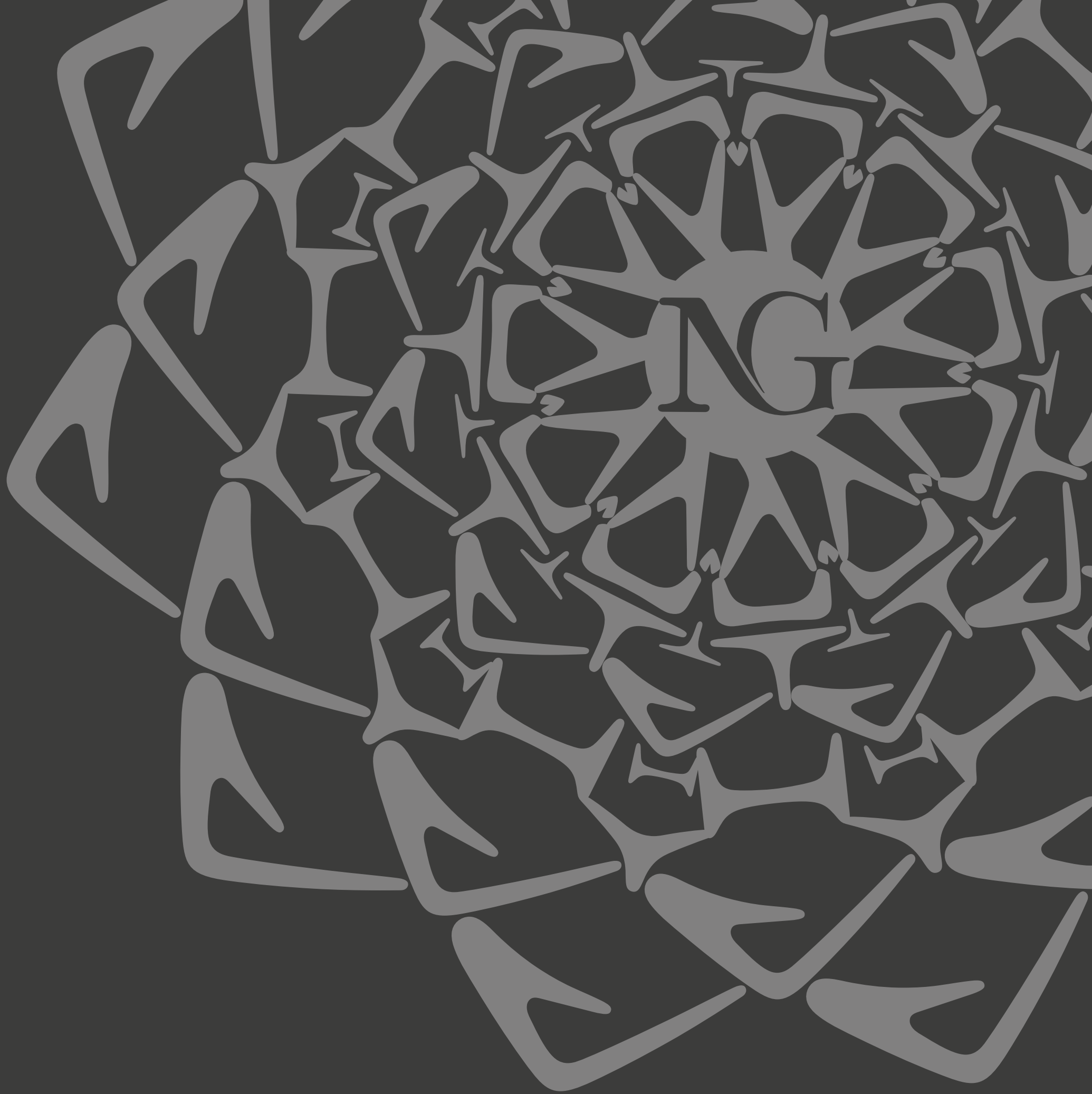

NG | KUTAHYA
USA

NG | STONE
PORCELAIN SLABS



ngkutahyausa.com

Address: 7855 NW 41st, Doral, FL 33166 Suite #200 Email: sales@ngkutahyausa.com Phone Number: (786) 953-6555